

Installation and Operation manual

For TCP/IP With 902 System

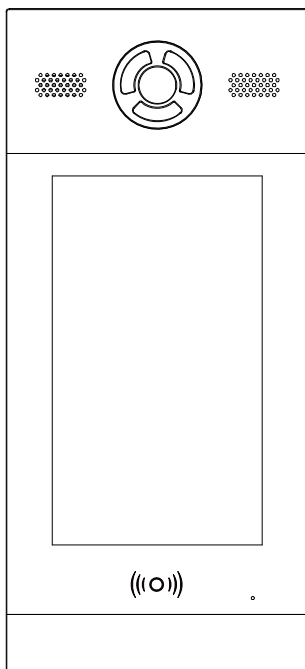

Outdoor Panel

■ Remark

Please follow the user manual for correct installation and testing. If there is any doubt please call our tech-supporting and customer center.

Our company applies ourselves to reformation and innovation of our products. No extra notice for any change. The illustration shown here is only for reference. If there is any difference, please take the actual product as the standard.

The product and batteries must be handled separately from household waste. When the product reaches the end of service life and needs to be discarded, please contact the local administrative department and put it in the designated collection points in order to avoid the damage to the environment and human health caused by any disposal. We suggest recycling and reusing the material resources.

CATALOG

Pictures.....	1
Basic Function	1
Technical Parameters.....	2
Package Contents.....	2
Basic Operation	3
Basic Settings	4
Web Settings	11
System Configuration	16
System Diagram.....	17
Installation.....	19
Troubleshooting.....	21
Safety Precaution.....	22

Basic Function

1. Video intercom with indoor monitor and management center
2. Optional IC/ID card reader, maximum 100,000 cards for unlocking
3. Access password unlocking, exit unlocking and door-detector function

Technical Parameters

1. Working voltage: DC12V
2. Rated power: 11W(X5)
13W(B6)
19W(B6)(Heating membrane)
15W(X5)(Heating membrane)
3. Standby power: 3W(X5/B6)
9W(B6)(Heating membrane)
7W(X5)(Heating membrane)
4. Working temperature: $-10^{\circ}\text{C}\sim+70^{\circ}\text{C}$
 $-40^{\circ}\text{C}\sim+70^{\circ}\text{C}$ (Heating membrane)
5. Humidity: 20%~93%
6. SDRAM: 512MB
7. Flash: 8GB
8. Max TF card capacity: 32GB
9. Camera: 1280*720CMOS
1920*1080CMOS(optional)

Package Contents

Model: B6

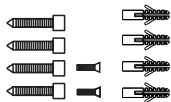

Screws



Screw Wrench

Model: X5



Screws



Screw Wrench

Pictures

Model: D-B6

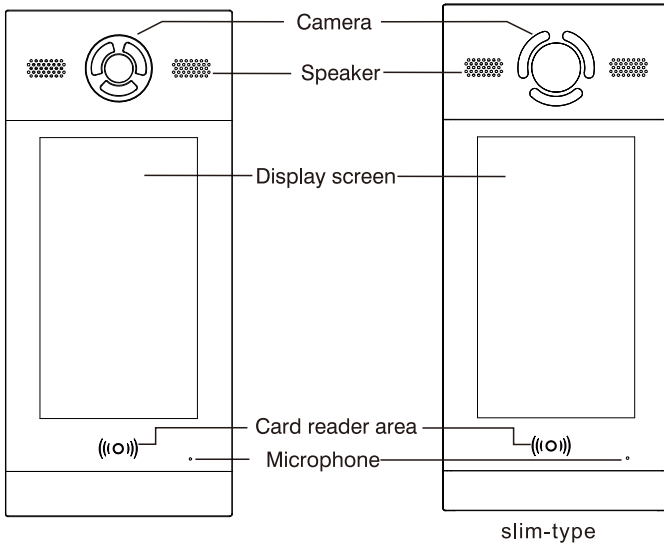

Model: D-X5 (7")

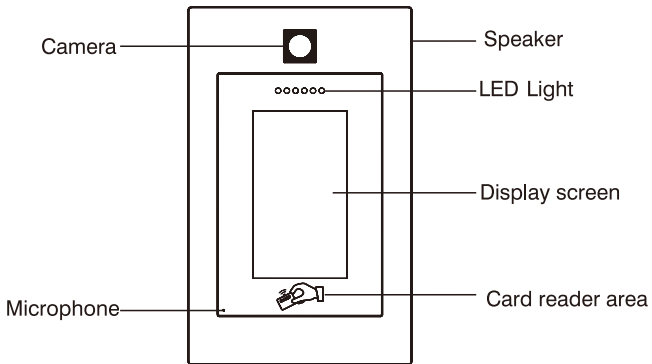

Note:

IR Detection: supports human body detection; Detecting Distance: 0.5~2.5m.

Basic Operation

Calling indoor monitor

When programmed as outdoor panel, input room number, then press # to confirm.

If you forget to press # to confirm the input, it will call indoor monitor automatically after 2 seconds .

If the number is correct, indoor monitor will ring. If the number is incorrect or the indoor monitor does not exist, the outdoor panel will display "Failure". After 2 seconds, it will return to standby mode.

If the indoor monitor is busy, the outdoor panel will display "Busy" and then automatically return to standby mode.

During communication, pressing "*" button on the outdoor panel, the call will be cut off.

Calling management center

In a standby mode, input "0000" (4 digits), then press # to call management center. If successful, outdoor panel displays "Calling", and the management center rings.

If the number is incorrect or the management center does not exist, the outdoor panel will display "Failure". After 2 seconds, it will return to standby mode.

If the management center is busy, the outdoor panel will display "Busy" and then automatically return to standby mode.

During communication, pressing "*" on the outdoor panel, the call will be cut off.

Unlock the door

1. Unlocking by access password

Press # key and enter the access password(The default is 0000). Then press # key to confirm. If the password is correct, the door will be unlocked; if not, it will make a sound like "Deng Deng".

2.Unlocking by IC/ID card

Put the registered IC/ID card on card reader area of the outdoor panel. If successful, the door will be unlocked.

3.Unlocking by Face Recognition

When someone puts his/her face close to the LCD screen, outdoor panel will automatically start the face recognition or the user can press the "*" key twice to enable the face recognition. If the face has been registered, the door will be unlocked.

Basic Settings

Pressing (#) key twice, the LCD screen will show as follows:

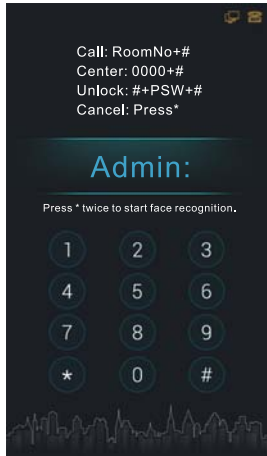

Enter the system password(Factory default is 123456) to the main menu.

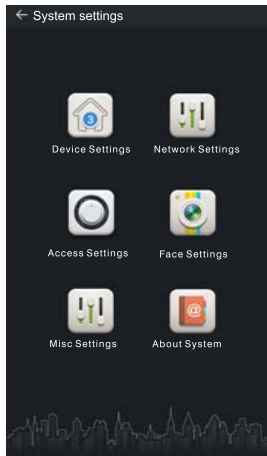

In System Settings page, you can set the following items.

1. Device settings

Press  to enter the following setting interface:

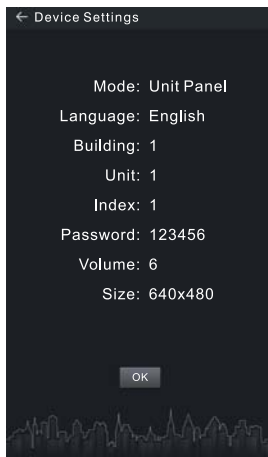

1.1 Device Mode

The device can be used as unit panel or wall panel. The device mode can be set through the item "Mode". Press "OK" to confirm after inputting. When the outdoor panel gives an indication tone, it means that it is changed successfully. If the device is used as unit panel, it can only call the indoor monitors in this unit. If the device is used as wall panel, it can call all the indoor monitors in the whole community.

1.2 Language, Volume and Size

The language, volume and size (resolution) are set in the same way as the settings of device mode. "Language" is used to set the language to be shown on the outdoor panel, supporting simplified Chinese, English, traditional Chinese and Spanish. "Volume" is used to set the prompt tone of outdoor panel, including 1-6 volume levels selection. There is 320x240, 640x480 or 1280x720 for the size.

1.3 Building No., Unit No., Index and Password

Select the item to go to settings ⇔ Input the number to change ⇔ Press "OK" to confirm ⇔ When the outdoor panel gives an indication tone, it means that it is changed successfully.

Note: Please keep the password confidential. If the password is forgotten, the user will not be able to log into the system. The password can only be recovered by resetting to factory defaults.

2. Network Settings

Press  to enter the following setting interface:

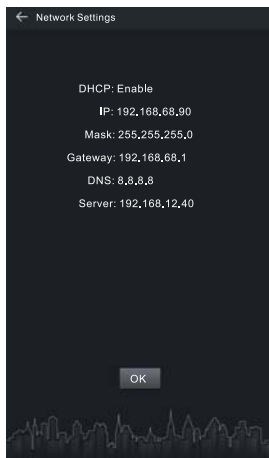

2.1 DHCP

Press this item to go to settings. Press “OK” to confirm after inputting. When the outdoor panel gives an indication tone, it means that it is changed successfully. The user can enable or disable the function.

2.2 IP

The default IP address of the system is 192.168.68.90. The LCD screen will display as shown above. As for the devices which are connected on the same LAN (the same subnet of network segment), their IP addresses cannot be the same.

2.3 Mask

The system default is 255.255.255.0. The LCD screen will display as shown above.

2.4 Default Gateway

It refers to the gateway address for network segment of device’s IP address. The system default is 192.168.68.1. The LCD screen will display as shown above.

2.5 DNS

The system default is 8.8.8.8. The LCD screen will display as shown above.

2.6 Server

The server address refers to the IP address of computer with management software. In case that management software isn't required for managing the intercom devices, this setting is invalid. The default IP address of server is 192.168.12.40. The LCD screen will display as shown above.

3. Access Settings

Press  to enter the following setting interface:

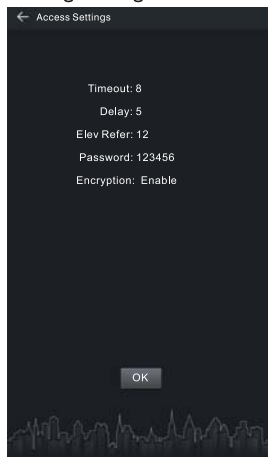

3.1 Timeout

The item is used for controlling the unlocking time, namely, how long it will take the door to shut automatically after unlocking.

Press this item to go to settings. Input any number from 1 to 9. If the user enters the number 8, it means the unlocking time is set at 8 seconds. Press "OK" to confirm after inputting. When the outdoor panel gives an indication tone, it means that the time is changed successfully.

3.2 Delay

The item is used for setting the delayed opening time, meaning how long it will delay unlocking the door after the user presses the unlock button on the indoor monitor.

Press this item to go to settings. The LCD screen will display as shown above. Input any number from 1 to 9. If the user enters the number 5, it means the delayed opening time is set at 5 seconds. Press "OK" for confirmation after inputting. When the outdoor panel gives an indication tone, it means that the time is changed successfully.

3.3 Password

The item is used for setting the password to unlock the door. Press this item to go to settings. Press “OK” to confirm after inputting. When the outdoor panel gives an indication tone, it means that it is changed successfully.

3.4 Elev Refer (This item can only be used after connection to elevator control devices)

The item is used for setting the floor No. of outdoor panel.

Press this item to go to settings. The LCD screen will display as shown above. Set the floor No. of outdoor panel ranging from 01 to 99. After the door is unlocked, the elevator will reach the floor of outdoor panel. Press “OK” to confirm after inputting. When the outdoor panel gives an indication tone, it means that it is changed successfully.

3.5 Encryption

Press this item to go to settings. Press “OK” to confirm after inputting. When the outdoor panel gives an indication tone, it means that it is changed successfully. The user can enable or disable the function.

4. Face Settings

Press  to enter the following setting interface:

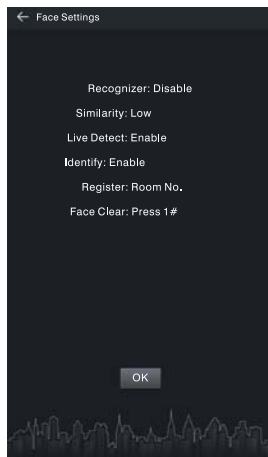

The item “Recognizer” is used for setting the state of recognizer function. “Disable” means the function has been closed. Press this item to go to settings. Press “OK” to confirm after inputting. When the outdoor panel gives an indication tone, it means that it is changed successfully.

The item “Similarity” is used for setting the face similarity. There are 3 levels to choose.

The item “Live Detect” means if you can move when being recognized.

The item “Identify” is used to enable or disable continuous face recognition.

The item “Register” is used for recording the new face. Enter the Room number and then register the face on the system of outdoor panel. When the system gives a prompt tone, it means the registration is completed.

The item “Face Clear” is used for clearing the registered information. Enter “1#” and then press “OK” to confirm.

5. Misc Settings

Press  to enter the following setting interface:

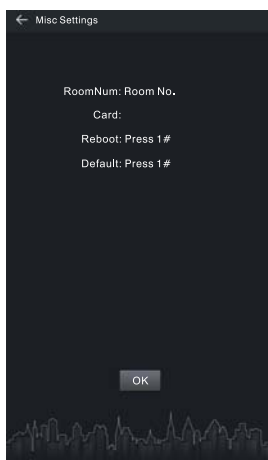

The item “RoomNum” is used for registering the access card corresponding to the room number. Press this item to go to settings. Press “OK” to confirm after inputting. When the outdoor panel gives an indication tone, it means that it is changed successfully.

Enter the room number and then place the access card close to the swiping area. When the outdoor panel gives an indication tone, it means that the card has been registered successfully. Then the No. of registered card will be displayed.

The item “Reboot” is used for restarting the outdoor panel. Enter the number “1#” and then press “OK” to confirm. The system will start automatically.

The item “Default” is used for resetting to system default. Enter the number “1#” and then press “OK” to confirm. The system will be reset.

6. About System

Press  to enter the following setting interface:

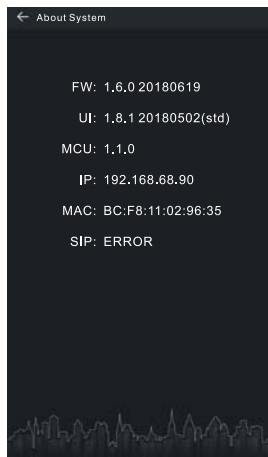

You can look over the relevant information.

Web Settings

Connect outdoor panel and PC in the network switch on the same LAN. Input IP address of outdoor panel in the web browser of PC, then input the user name and password(the default name is admin, the password is 123456) to enter into the following interface:

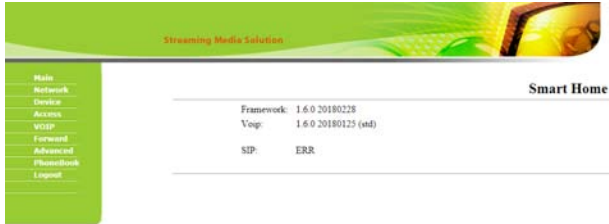

1. Network Settings:

Click "Network" icon on the interface to enter into the following interface:



IP: IP address should be unique on the same Network.

Mask: the default Mask is 255.255.255.0.

Gateway: it depends on IP address.

DNS: it depends on Network.

Server IP: it is the same as the IP address of management PC.

Password: the password to connect management PC.

Usually, the communication among management center, indoor monitor and outdoor panel will be available on the same LAN; if they are not on the same Network, you need to set SIP server to support the communication.

Click "Submit" icon to confirm settings.

2. Device Settings:

Click "Device" icon on the interface to enter into the following interface:

Streaming Media Solution

Device Settings

BuildNo:

UnitNo:

No:

Sys password:

Panel mode:

Language:

Volume:

Video:

Forward:

Dial Mode:

The settings of building and Unit No. should be the same as that of corresponding outdoor panel.

No.: It is unique number for the outdoor panel. You can have max.9 outdoor panels in one house and distinguish them by the number from 1 to 9.

Sys password: you can change the login password as you like (the default password is 123456).

Panel mode: unit panel, wall panel or personal panel for selection.

① Unit panel: Used in one unit, it can call residents in the unit and management center;

② Wall panel: Used in the entrance of community, it can call all indoor monitors in the community and management center;

③ Personal panel: It is reserved.

You can choose different ringtone and language, and can also adjust the ringing volume.

Click "Submit" icon to confirm settings.

3. Access Settings:

Click "Access" icon on the interface to enter into the following interface:

Streaming Media Solution

Access Settings

Unlock Timeout:

Unlock Delay:

Elder refer:

Admin Card:

Security ON/OFF:

Unlock Password:

0000			

Unlock Timeout is used for controlling the unlocking time ranging from 1 to 9 seconds.

Unlock Delay refers to the delayed opening time ranging from 0 to 9 seconds.

Elev refer is used for setting the floor No. of outdoor panel ranging from 01 to 99.

Security ON/OFF: arming/disarming by card is only available for secondary outdoor panel; unit panel only supports disarming by card.

Unlock Passwd: it's used for unlocking the door. The system default is 0000. Eight unlocking passwords can be added.(This is only applicable for outdoor panel with keypad.)

Card Registration:

The Admin Card is used for registering user card. There are two ways to register the admin card:

1. The user enters card No. of the admin card in the box after “Admin Card” and then clicks the key “Submit”. In this case, the admin card is registered successfully.

2. If the user isn't aware of admin card No., please enter 0 in the box first and click the key “Submit”. Then place the admin card close to the swiping area. When the system gives an indication tone, it means that the card is registered successfully.

When registering the user card, the user should swipe the admin card first. The system emits a beep. Then place the card to be registered near the swiping area within 10 seconds. If the system gives an indication tone, it means that the user card is registered successfully. When registering the user card, the card to be registered should be swiped 10 seconds after the admin card is swiped. Once an user card is registered, it will postpone for 10 seconds. When there is no activity for 10 seconds, the system will exit from registration status automatically. To register a new user card, the user should swipe the admin card again.

4. VOIP:

Click “VOIP” icon on the interface to enter into the following interface:

Streaming Media Solution

SIP Settings

SIP enable

Proxy:

Realm:

Outbound:

STUN IP:

STUN Port:

H.264:

User:

Password:

Timeout:

Ringing:

SIP enable: when SIP account No. is enabled, the SIP server of a third party is generally used.

Proxy: URL of SIP proxy server in format: sip: ip or sip: domain name.

Realm: realm of the device, generally the same as IP or domain name.

STUN IP and Port refer to the IP and port of public server for NAT traversal of audio and video.

H.264(102): 128K, 384K, 512K, 768K, 1M or 2M

User: user name assigned by SIP server

Password: password assigned by SIP server

Timeout: 120 seconds, 300 seconds, 600 seconds, 1200 seconds or 1800 seconds.

Ringling: ringing time of indoor monitor which is called by outdoor panel can be set. The time can be set at 35 seconds, 45 seconds, 60 seconds, 90 seconds or 120 seconds.

Once this is set up, click the key "Submit" to enable new settings.

5. Forward (Call transfer):

Click "Forward" icon on the interface to enter into the following interface:

The screenshot shows a web interface for 'Forward Account Settings'. It features a green header with the text 'Streaming Media Solution' and a navigation menu on the left with items like 'Home', 'Network', 'Device', 'Account', 'SIP', 'Forward', 'Advanced', 'Phonebook', and 'Logout'. The main content area has the following elements:

- Forward Account Settings** (Section Header)
- RoomNo:
- Account:
- Delete:
-
- Table with columns: RoomNo, Account, RoomNo, Account, RoomNo, Account

Room No. can be bound with phone number. When the visitor calls on the outdoor panel but there is no answer within 25 seconds, the system will forward the call to the phone. Please follow the detailed steps:

1. Enter the room No. and then enter the account phone number to be bound;
2. To delete this account, check the box;
3. Once this is set up, click the key "Submit" to enable new settings.

(Note: This item requires support of extension module or local SIP service provider).

6. Advanced

Click “Advanced” icon on the interface to enter into the following interface:



The screenshot shows the 'Advanced Settings' page of the Streaming Media Solution interface. On the left is a green navigation menu with options: Home, Network, Device, Access, VoIP, Forward, Advanced (highlighted), Phonebook, and Logout. The main content area is titled 'Advanced Settings' and contains several configuration options: Advertising (checkbox), Quick Call (checkbox), Voice GW (checkbox), Speed Dial (checkbox), OOS/ Pass (checkbox), IR Sensor (checkbox checked), Face (checkbox), Similarity (dropdown menu set to 'Low'), RTP Feed (dropdown menu set to 'Disable'), and a Submit button at the bottom.

Advertising: check the box to enable this function. Enter the specified advertisement URL in the box. The interface will play the online advertisement automatically.

Quick Call: check the box to enable this function. It refers to the call to management center. Enter the SIP address of specified management center. The call can be from indoor monitor or SIP internet phone of other manufacturers.

Speed Dial: press one number key to give a direct call.

Face: check the box to enable face recognition function. Three similarity levels for selection: low, normal or high.

Once this is set up, click the key “Submit” to enable new settings.

7. Logout

Click “Logout” icon on the interface to enter into the following interface:



The screenshot shows the 'User Logout' page of the Streaming Media Solution interface. On the left is the same green navigation menu as in the previous screenshot, with 'Logout' highlighted. The main content area is titled 'User Logout' and contains the text 'Please click [Submit] to logout user!' and a Submit button.

Click “Submit” icon to log out the system.

System Configuration

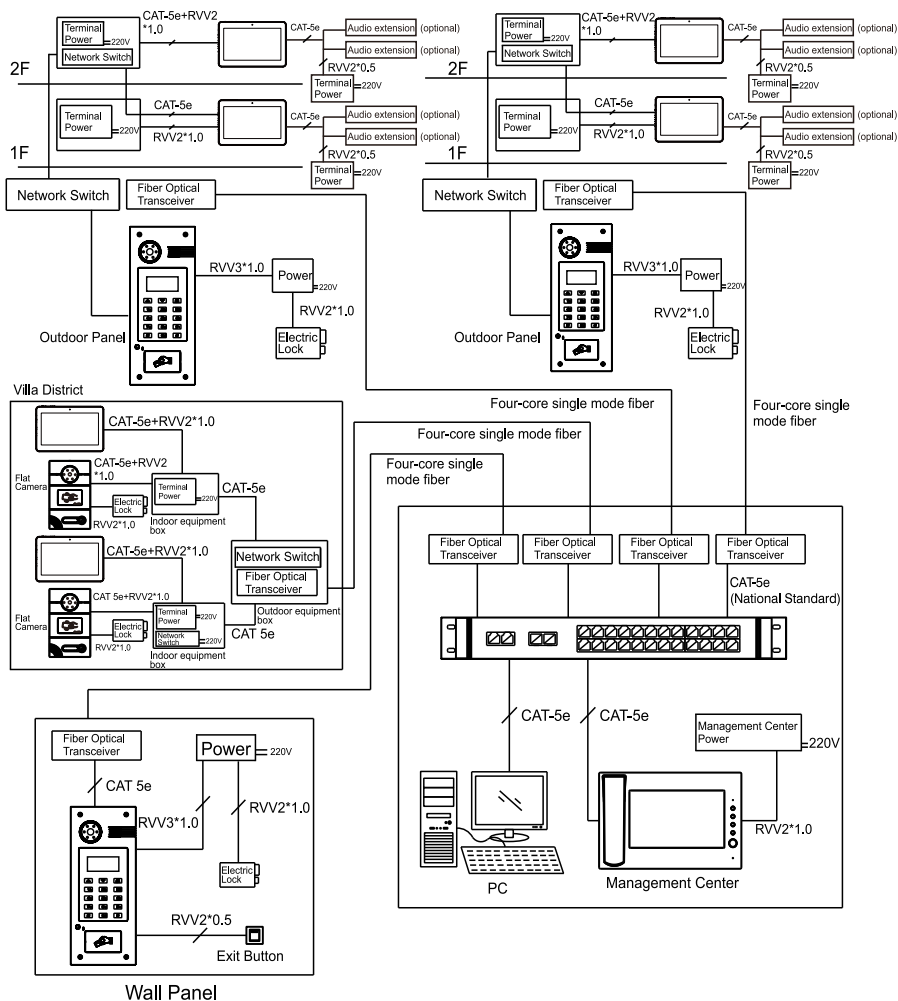

System Diagram

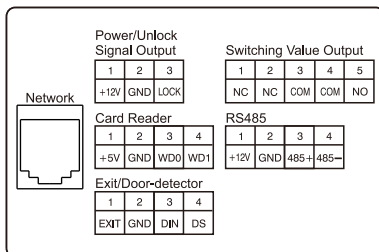

1. Network

Standard RJ45 interface connects with management center, indoor monitor or other network equipment by network switch.

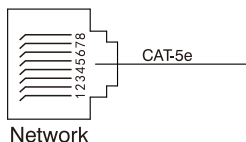

2. Power/ Unlock Signal Output

Power interface of outdoor panel connects with 12V DC power. Unlock signal input connects with unlock module.

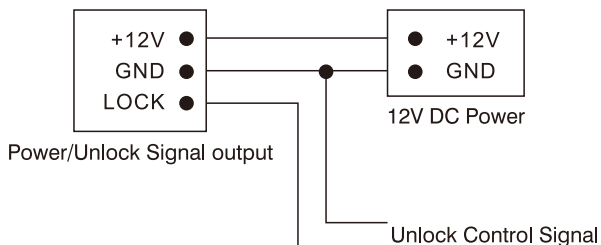

3. Switching Value Output

Connect to the lock module (independent power supply is necessary for the lock).

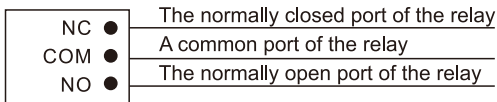

Switching Value Output

4. RS485

Enable to connect equipment with RS485 interface. RS485 interface can output 12V/100mA power. +12V isn't required for wiring if it is unused.

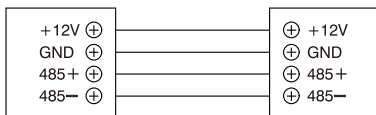

RS485 Interface RS485 Equipment

5. Exit/ Door-detector

Connect with exit /door-detector.

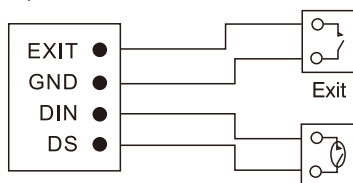

Exit/Door-detector Door-detector Sense Switch

6. Card Reader Interface

The interface can be connected to one IC/ID card reader or be used for reading the information of built-in card reader. It can output the power 5V/100mA. When the card reader doesn't need the power from the interface, connection of +5V isn't required.

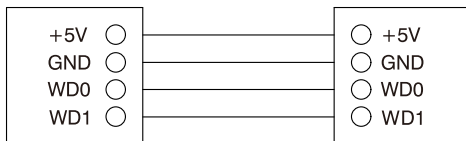

Card Reader Interface IC/ID Card Reader or Management Device

Note: Only one card reader can be connected to outdoor panel. When there is built-in card reader, the interface can only be used for reading the information of built-in card reader.

Installation

Model: D-B6

Product size: 180*400*45mm
Built-in box size: 172*373*58mm
Trepanning size: 176*377*60mm

Break through the cord hole on the bottom of the built-in box first for water draining. Please don't cover the drain hole with the glass cement.

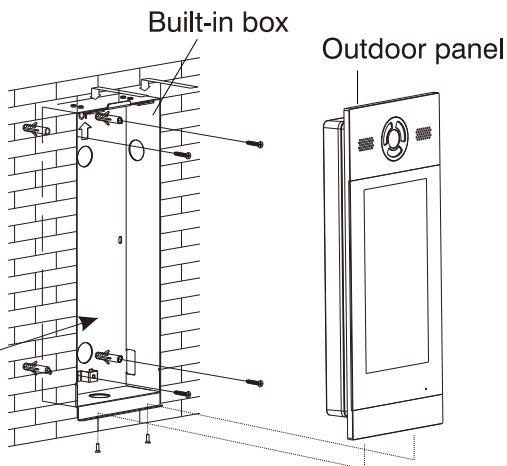

Model: D-X5(7")

Product size: 205*328*48mm
Built-in box size: 188*315*50mm
Trepanning size: 192*320*55mm

Break through the cord hole on the bottom of the built-in box first for water draining. Please don't cover the drain hole with the glass cement.

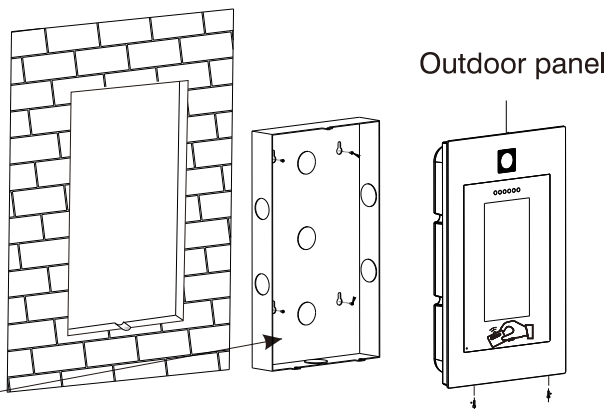

Installation Instructions:

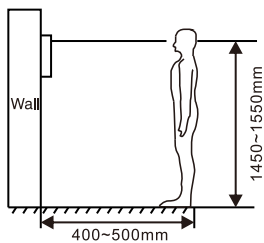

[Suggestion]: During the installation, the camera should be 1450~1550mm above the ground. The camera tether for photographing human face should be the top priority.

Troubleshooting

Some common failures and troubleshooting methods are listed for your reference. In case of failure which cannot be repaired, do not disassemble or repair the product by yourself. Please contact the after-sales service department.

When unit panel or wall panel fails to call indoor monitor:

- When setting outdoor panel, please make sure building No. and unit No. of outdoor panel are the same as the ones of indoor monitor;
- Please check whether the network is connected;
- Please check if there are any security settings for the network, such as VLAN configuration;

When unit panel, wall panel or indoor monitor fails to call management center :

- Please check whether the network is connected;
- Please check if there are any security settings for the network, such as VLAN configuration;

Safety Precaution

In order to protect you and others from harm or your device from damage, please read the following information before using the device.

Do not install the device in the following places:

- Do not install the device in high-temperature and moist environment or the area close to magnetic field, such as the electric generator, transformer or magnet.
- Do not place the device near the heating products such as electric heater or the fluid container.
- Do not place the device in the sunshine or near the heat source. This might cause discoloration or deformation of the device.
- Do not install the device in an unstable position to avoid the property losses or personal injury caused by the falling of device.

Guard against electric shock, fire and explosion

- Do not use damaged power cord, plug or loose outlet.
- Do not touch the power cord with wet hands or unplug the power cord by pulling.
- Do not bend or damage the power cord.
- Do not touch the device with wet hands.
- Do not make the power supply slip or cause the impact.
- Do not use the power supply without the manufacturer's approval.
- Do not have the liquids such as water go into the device.

Clean Device Surface

- Clean the device surfaces with soft cloth dipped in some water, and then rub the surface with dry cloth.

Other Tips

- In order to prevent damage to the paint layer or the case, please do not expose the device to chemical products, such as the diluent, gasoline, alcohol, insect-resist agents, opacifying agent and insecticide.
- Do not knock on the device with hard objects.
- Do not press the screen surface. Overexertion might cause floppover or damage to the device.
- Please be careful when standing up from under the device.
- Do not disassemble, repair or modify the device at your own discretion. The arbitrary modification is not covered under warranty. When any repair required, please contact the customer service center.
- If there is abnormal sound, smell or fume in the device, please unplug the power cord immediately and contact the customer service center.
- When the device isn't used for a long time, the adaptor and memory card can be removed and placed in dry environment.
- When moving, please hand over the manual to new tenant for proper usage of the device.

